

# Pressure transmitter for general applications

## Model S-10, standard version

## Model S-11, flush diaphragm

WIKA Data Sheet PE 81.01



### Applications

- Mechanical engineering
- Hydraulics / Pneumatics
- General industrial applications
- Food & Beverage

### Special Features

- Pressure ranges from 0 ... 0.1bar to 0 ... 1000 bar
- Various industrial standard signal outputs
- Wiring with connector or flying leads
- Stock programm for short delivery times
- Vacuum tight



Fig. left Pressure transmitter S-10

Fig. center Pressure transmitter S-11

Fig. right Pressure transmitter S-11 with cooling element

### Description

This series of pressure transmitters has been carefully designed to cover the majority of industrial applications with instruments readily available from stock.

Compact design and robust construction make these instruments suitable for all applications in machine construction, process control, laboratory or quality and materials testing equipment.

There is an extraordinary range of instrument variants resulting from the fact that various mechanical and electrical connections can be combined with each other to almost any extent.

### Structure

All wetted parts are made of stainless steel and are hermetically welded. Therefore there is no need for additional sealing material, which could possibly react with the pressure medium. The compact case is also made of stainless steel and provides IP 65 ingress protection (special versions up to IP 68).

The transmitters can be supplied with a non-stabilized direct voltage of 10 (14) ... 30 V and provide standard industrial output signals.

The model S-11 with flush diaphragm is particularly suitable for the measurement of viscous fluids or media containing particulates that may clog the pressure connection of standard industrial transmitters. Thus, a trouble-free pressure measurement is ensured. Pressure transmitters with flush diaphragm are available in pressure ranges from 0 ... 0.1bar to 0 ... 600 bar. For applications with higher temperature requirements an integrated cooling element enables medium temperatures of up to 150 °C (302 °F).

For the pressure ranges from 0 ... 0.25 bar up to 0 ... 1000 bar the pressure transmitters can be delivered for oxygen applications (technical safety check of the BAM, Bundesanstalt für Materialforschung und -prüfung available).

## Specifications

## Model S-10 / S-11

Pressure ranges <sup>*</sup>	bar	0.1	0.16	0.25	0.4	0.6	1	1.6	2.5	4	6	10
Over pressure safety	bar	1	1.5	2	2	4	5	10	10	17	35	35
Burst pressure	bar	2	2	2.4	2.4	4.8	6	12	12	20.5	42	42
Pressure ranges	bar	16	25	40	60	100	160	250	400	600	1000 <sup>1)</sup>	
Over pressure safety	bar	80	50	80	120	200	320	500	800	1200	1500	
Burst pressure	bar	96	96	400	550	800	1000	1200	1700 <sup>2)</sup>	2400 <sup>2)</sup>	3000	
{Vacuum, gauge pressure, compound range, absolute pressure, other pressure ranges and units are available}												
<sup>1)</sup> Only Model S-10.												
<sup>2)</sup> For model S-11: the value specified in the table applies only when sealing is realised with the sealing ring underneath the hex. Otherwise max. 1500 bar applies.												
Materials		(other materials see WIKA diaphragm seal program)										
■ Wetted parts		Stainless steel										
➢ Model S-10 <sup>*</sup>		Stainless steel {Hastelloy C4}										
➢ Model S-11		O-ring: NBR <sup>3)</sup> {FPM/FKM or EPDM}										
■ Case		Stainless steel										
Internal transmission fluid <sup>4)</sup>		Synthetic oil {Halocarbon oil for oxygen applications}										
		{Listed by FDA for Food & Beverage}										
<sup>3)</sup> O-ring made of FPM/FKM {EPDM} for Model S-11 with integrated cooling element.												
<sup>4)</sup> Not for S-10 with pressure ranges > 25 bar												
Power supply U <sub>B</sub>	U <sub>B</sub> in DC V	10 < U <sub>B</sub> ≤ 30 (14 ... 30 with signal output 0 ... 10 V)										
Signal output and maximum load R <sub>A</sub>	R <sub>A</sub> in Ohm	4 ... 20 mA, 2-wire R <sub>A</sub> ≤ (U <sub>B</sub> - 10 V) / 0.02 A										
		0 ... 20 mA, 3-wire R <sub>A</sub> ≤ (U <sub>B</sub> - 3 V) / 0.02 A										
		{0 ... 5 V, 3-wire} R <sub>A</sub> > 5,000										
		{0 ... 10 V, 3-wire} R <sub>A</sub> > 10,000 {other signal outputs on request}										
Adjustability zero/span	%	± 10 using potentiometers inside the instrument										
Response time (10 ... 90 %)	ms	≤ 1 (≤ 10 ms at medium temperatures below -30 °C for pressure ranges up to 25 bar or with flush diaphragm)										
Dielectric strength	DC V	500 <sup>5)</sup>										
<sup>5)</sup> NEC Class 02 power supply (low voltage and low current max. 100 VA even under fault conditions)												
Accuracy	% of span	≤ 0.25 {0.125} <sup>6)</sup> (BFSL)										
	% of span	≤ 0.5 {0.25} <sup>6) 7)</sup>										
<sup>6)</sup> Accuracy { } for pressure ranges ≥ 0.25 bar												
<sup>7)</sup> Including non-linearity, hysteresis, non-repeatability, zero point and full scale error (corresponds to error of measurement per IEC 61298-2). Adjusted in vertical mounting position with lower pressure connection.												
Non-linearity	% of span	≤ 0.2 (BFSL) according to IEC 61298-2										
1-year stability	% of span	≤ 0.2 (at reference conditions)										
Permissible temperature of												
■ Medium <sup>8) *</sup>		-30 ... +100 °C {-40 ... +125 °C}					-22 ... +212 °F {-40 ... +257 °F}					
		S-11 with cooling element: -20 ... +150 °C					S-11 with cooling element: -4 ... +302 °F					
■ Ambience <sup>8)</sup>		-20 ... +80 °C					-4 ... +176 °F					
		S-11 with cooling element: -20 ... +80 °C					S-11 with cooling element: -4 ... +176 °F					
■ Storage <sup>8)</sup>		-40 ... +100 °C					-40 ... +212 °F					
		S-11 with cooling element: -20 ... +100 °C					S-11 with cooling element: -4 ... +212 °F					
<sup>8)</sup> Also complies with EN 50178, Tab. 7, Operation (C) 4K4H, Storage (D) 1K4, Transport (E) 2K3												
Compensated temp. range		0 ... +80 °C					32 ... +176 °F					
Temperature coefficients within compensated temp range												
■ Mean TC of zero	% of span	≤ 0.2 / 10 K (< 0.4 for pressure range ≤ 250 mbar)										
■ Mean TC of range	% of span	≤ 0.2 / 10 K										
CE- conformity		89/336/EEC interference emission and immunity see EN 61 326, interference emission limit class A and B, 97/23/EC Pressure equipment directive (Module H)										
Shock resistance	g	1000 according to IEC 60068-2-27 (mechanical shock)										
Vibration resistance	g	20 according to IEC 60068-2-6 (vibration under resonance)										
Wiring protection		Protected against reverse polarity and short circuiting on the instrument side										
Mass	kg	Approx. 0.2 / Approx. 0.3 with option accuracy 0.25% of span due to longer case										

<sup>\*</sup> In an oxygen version model S-11 is not available. In an oxygen version model S-10 is only available in gauge pressure ranges ≥ 0.25 bar with media temperatures between -20 ... + 60 °C / -4 ... +140 °F and using stainless steel or Elgiloy<sup>®</sup> wetted parts.

{ } Items in curved brackets are optional extras for additional price.

# Dimensions in mm

## Electrical connections

## Ingress Protection IP per IEC 60 529

L-connector,  
DIN EN 175301-803, Form A  
for conductor cross section  
up to max. 1.5 mm<sup>2</sup>,  
conductor outer diameter  
6 - 8 mm,  
IP 65  
Order code: A4

Circular connector  
M 12x1, 4-pin,  
IP 67  
Order code: M4

Flying leads  
conductor cross section up  
to max. 0.5 mm<sup>2</sup> /  
AWG 20 with end splices,  
conductor outer diameter  
6.8 mm, IP 67  
Order code: DL

Flying leads, zero/span not adjustable,  
conductor cross section up to max.  
0.5 mm<sup>2</sup> / AWG 20 with end splices,  
conductor outer diameter 6.8 mm,  
IP 68  
Order code: EM

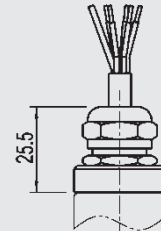
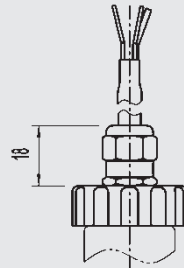
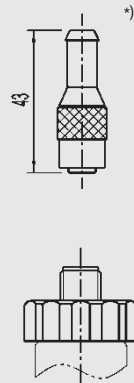
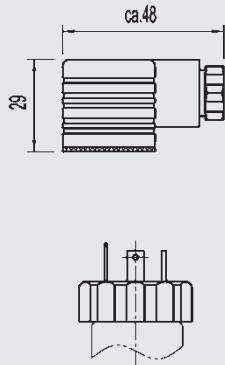

Others on request

## Case

Case at 0.25 %  
accuracy

Case at 0.5 %  
accuracy

Case at 0.25 %  
accuracy

Case at 0.5 %  
accuracy

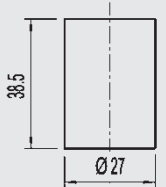
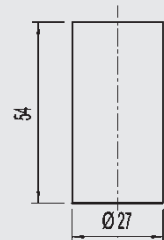
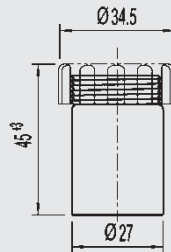
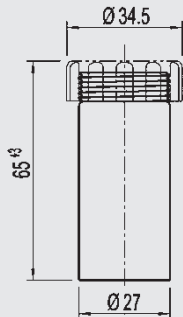

## Pressure connections S-10

G 1/2  
EN 837  
Order code: GD

G 1/4  
EN 837  
Order code: GB

G 1/4  
DIN 3852-E  
Order code: HD  
(over pressure  
safety  
max. 600 bar)

1/2 NPT  
per „Nominal size for US  
standard tapered  
pipe thread NPT“  
Order code: ND

1/4 NPT  
per „Nominal size for  
US standard tapered  
pipe thread NPT“  
Order code: NB

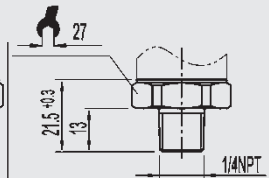
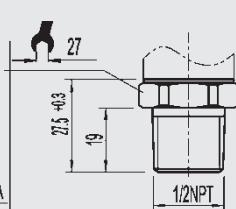
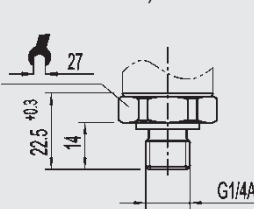
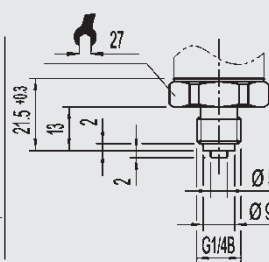
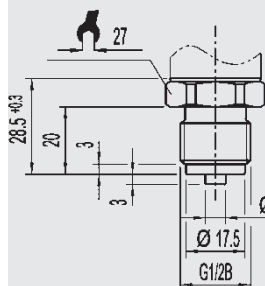

Others on request

For installation and safety instructions see the operating instructions for this product.

For tapped holes and welding sockets please see Technical Information IN 00.14 for download at [www.wika.de](http://www.wika.de) -Service

\*) Connectors are not included in delivery

## Dimensions in mm

### Pressure connections S-11, flush diaphragm

G 1/2 B  
with or without cooling element  
0 ... 2.5 up to 0 ... 600 bar  
Order code: 86

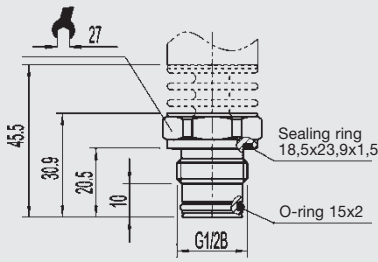

G 1 B  
with or without cooling element  
0 ... 0.1 up to 0 ... 1.6 bar  
Order code: 85

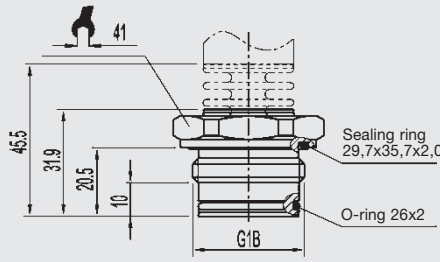

G 1 B  
acc. EHEDG \*\*)  
with cooling element, up to 150 °C  
up to 25 bar  
Order code: 84

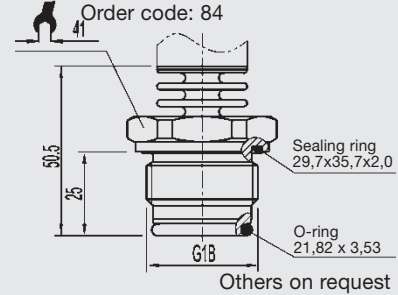

Others on request

For installation and safety instructions see the operating instructions for this product.

For tapped holes and welding sockets please see Technical Information IN 00.14 for download at

[www.wika.de](http://www.wika.de) -Service

\*\* European Hygienic Equipment Design Group

## Wiring details

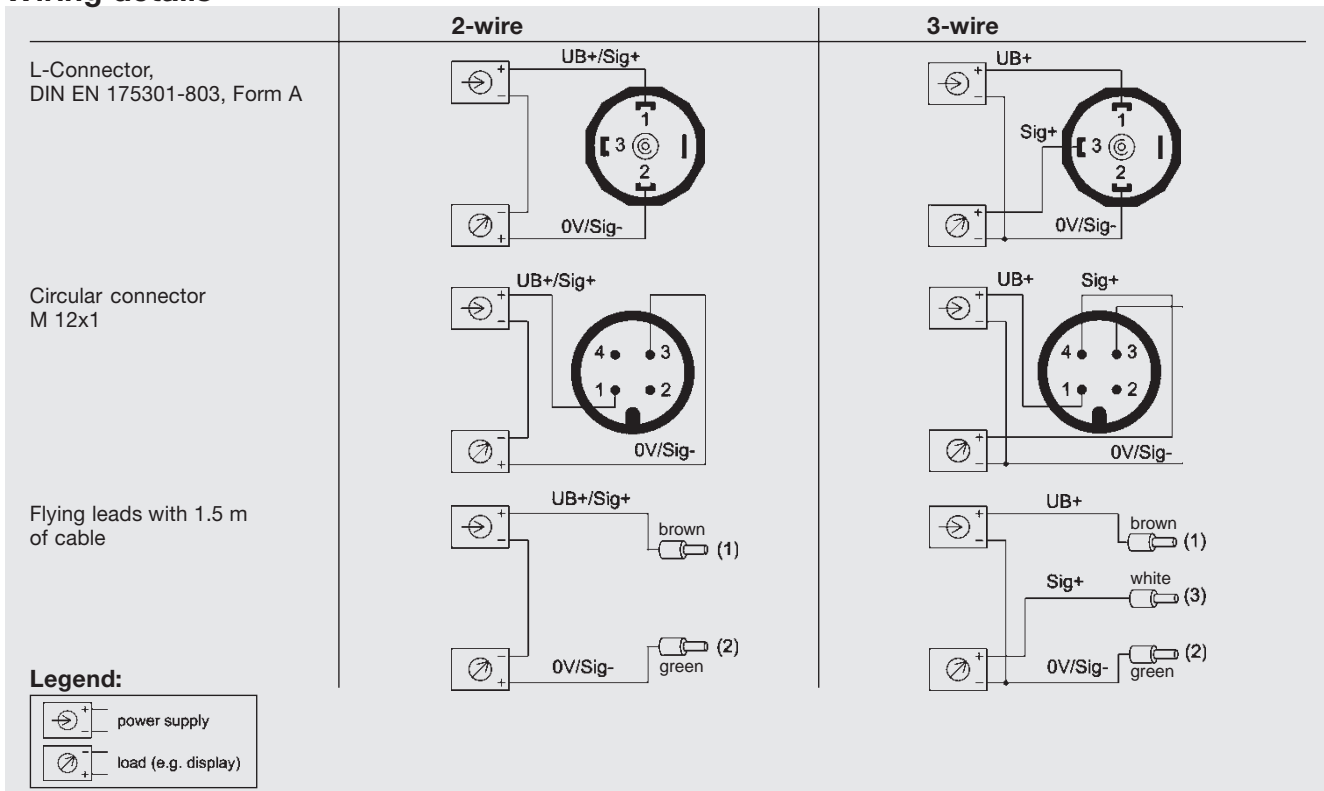

## Accessories

Order-No.	
	<b>S-11</b>
11 92 299	G 1/2 Weld-on adaptor
11 92 264	G 1 Weld-on adaptor

Specifications and dimensions given in this leaflet represent the state of engineering at the time of printing. Modifications may take place and materials specified may be replaced by others without prior notice.



**WIKAL Alexander Wiegand GmbH & Co. KG**  
Alexander-Wiegand-Straße 30  
63911 Klingenberg/Germany  
Phone (+49) 93 72/132-0  
Telefax (+49) 93 72/132-406  
E-Mail [support-tronic@wika.de](mailto:support-tronic@wika.de)  
[www.wika.de](http://www.wika.de)